



DH Catalogue

TI
D

10



PROEL GROUP

Proel Group consists of four leading companies operating worldwide, in the design manufacture and distribution of audio, video and lighting systems for entertainment, events and fixed installations.

The Proel Group headquarters are located in central Italy. International markets are covered by a consolidated network of distributors, allowing the company to export its products to more than 120 countries.

In 2008, Proel opened a state of the art 13,500 sq metre dedicated automated logistics facility adjacent to the Italian headquarters.

To supplement this facility and ensure an efficient structured logistics operation Proel also provides direct shipments from its' Asia manufacturing plants to international business partners.

The Proel Group of companies consists of:

Proel S.p.A.

Parent company with headquarters located in the province of Teramo, central Italy is a leader in the design, manufacture and worldwide distribution of professional audio equipment, lighting systems and accessories.

Turbosound LTD

Turbosound is a leading designer and manufacturer of professional loudspeaker systems. Their unique, award winning designs have generated many principle patents and their products adopted by many major international artists and prestigious installations around the world.

Proel America LLC

Proel America is the distribution, support and logistics company for Proel products in the North American market. Proel America is based in Miami, Florida.

Proel International LTD

Proel International is a full service distribution company for Proel products in the UK market. Proel International is based in London.

Proel is particularly committed to Research & Development to ensure continual product innovation, optimisation of product performance and evolution of product ranges. Proel Group R&D function centres around three state of the art facilities, located in Italy and the U.K.

In addition to the new product development, a key focus of these centres is the optimisation of production cycles and process engineering.

Proel has established its current market position as the result of these investments in Research and Development, direct product design and maximum and ongoing commitment to quality and innovation. This commitment to product development is backed up by a dedication to the pre/post sales service and a strong and consolidated distribution network throughout the world.

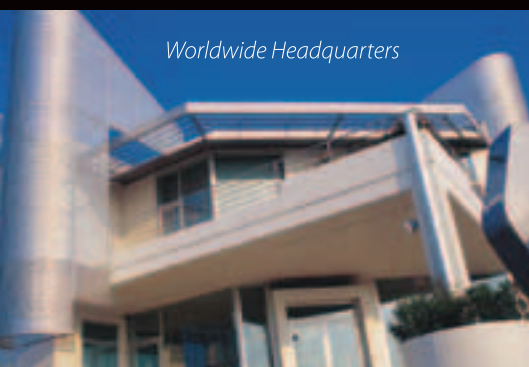

Worldwide Headquarters



Logistic Park



R&D Department

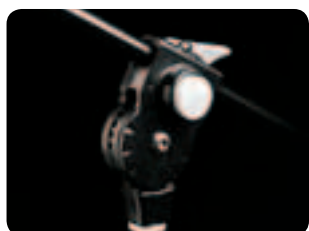

METAL SYSTEM ▣ 5



ASSEMBLED CABLES
AND ADAPTERS ▣ 13



AUDIO STAGE BOXES ▣ 25



BAGS ▣ 29



Metal system

Providing the solution to numerous requests made by an increasingly demanding market. The new product line shows the great attention to detail and the use of the latest generation of raw materials, continuing the DH tradition recognised all over the world as a synonym of quality.

During the design and creation of these products, PROEL worked closely with many international industry professionals. These brainstorming sessions provided a wealth of ideas for the best on-stage solutions. Combined together, these factors have assisted in the creation of the new series of stands and accessories. The product range provides solutions for different applications.

Through continuous research and the use of the latest cutting edge technology, a dedicated, specialised design team have delivered a reliable, stylish and high performance product line well in keeping with the demanding expectations of musicians worldwide.





Metal system

GUITAR STANDS

DHGS10

Guitar stand

Open dimension	L 330 mm x H 340 mm x P 300 mm
Close dimension	L 300 mm x H 380 mm x P 45 mm
Weight	0,865 Kg
Load capacity	15 Kg

Simply-to-use universal lightweight construction guitar stand. The use of high quality plastic ensures extreme stability. This stand has got a innovative blocking system mechanism easy to use. The support arms are lined with a special grey rubber material to protect the instrument finish. Available colour: matt black.

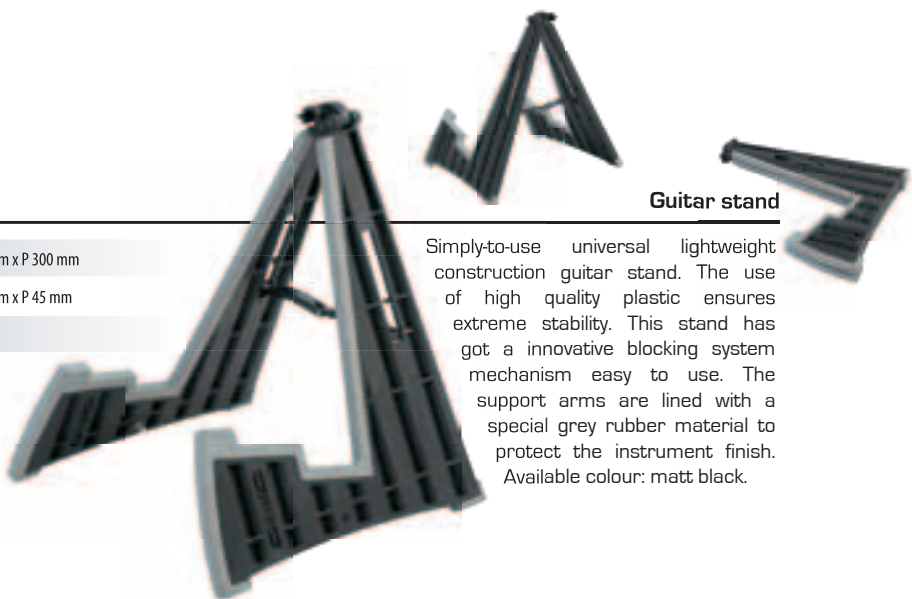

DHGS40

NEW

Guitar stand

Height	750 / 1150 mm
Weight	1,59 Kg
Load capacity	12 Kg
Ø Base	620 mm
Folded dimensions	640 x 90 x 90 mm

• New universal floor guitar stand with height adjustment system. Equipped with an AUTO-LOCK closing system automatically securing the guitar on the snap-hook. All the parts touching the instrument are lined with soft rubber to protect the instrument finish. Available colour: matt black.

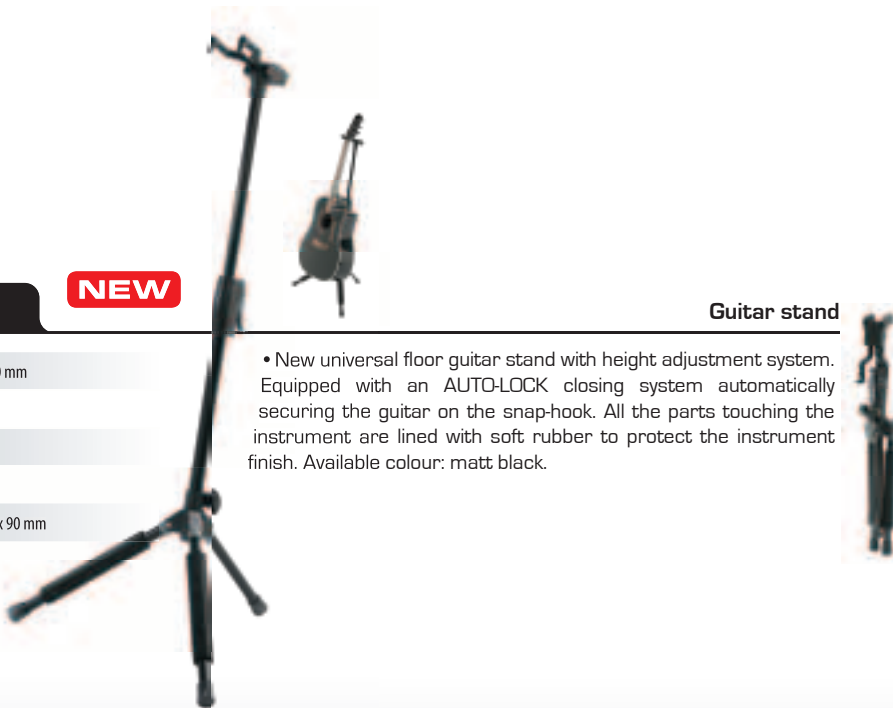



GUITAR STANDS

- New wall mount and slat wall mount guitar stands. Equipped with an AUTO-LOCK closing system automatically securing the guitar on the snap-hook. The ends of the blocking mechanism are soft rubber covered to protect the instrument finish. Recommended for shop or exhibition display. Available colour: matt black.



DHGSW25

NEW

Wall mount guitar stand

180° regulation wall mount stand.
Weight: 0,495 kg - Maximum load:
10 kg - Depth: 405 mm



NEW

DHGSW15

Wall mount guitar stand

Wall mount straight stand.
Weight: 0,290 kg - Maximum load:
10 kg - Depth: 215 mm



NEW

DHGSW35

Wall mount guitar stand

Slat-wall mount straight stand.
Weight: 0,280 kg - Maximum load:
10 kg - Depth: 215 mm





Metal system

KEYBOARD STANDS

NEW

NEW IMPROVED STABILITY!

DHKS10SL



DHKS10

Keyboard stand

DHKS10BK (Matt black) DHKS10SL (Grey)	
Height	1040 mm
Tiers length	lower 440 mm / upper 390 mm
Weight	7,50 Kg
Maximum load	lower tier 25 Kg * / upper tier 20 Kg *
Folded dimensions	1200 mm x 150 mm x 150 mm

* Load capacity is 25 kg lower tier and 20 kg for the upper tier when the legs are levelled and positioned firmly on the surface.

Column style keyboard stand, now with additional 3rd leg enhanced stability! Constructed from robust steel tubing and extruded aluminium profile, this roadworthy stand is built with maximum reliability in mind. Other features include double height adjustment arms and legs that retract inside the centre column allowing easy transportation inside the included carrying bag.

DHKS40/50 technical info

OPEN POSITION	WIDTH	HEIGHT
1	485 mm	950 mm
2	590 mm	880 mm
3	700 mm	820 mm
4	790 mm	710 mm

Keyboard stand

New single braced heavy duty and sturdy construction keyboard stand. Featuring high-grade steel tubing and die cast aluminium junctions that ensure maximum reliability. Provided with a new easy release mechanism at the touch of a lever that allows a quick set and selection one of four different height positions. Self-levelling rubber caps are supplied for adjustment on uneven surfaces and ensure extra stability. Supplied disassembled for easy shipping. Available colour: matt black with grey insert.

DHKS40

Tier depth:	380 mm
Weight:	4,24 Kg
Max loading weight	60 Kg
Folded dimension:	1050 x 135 x 510

NEW

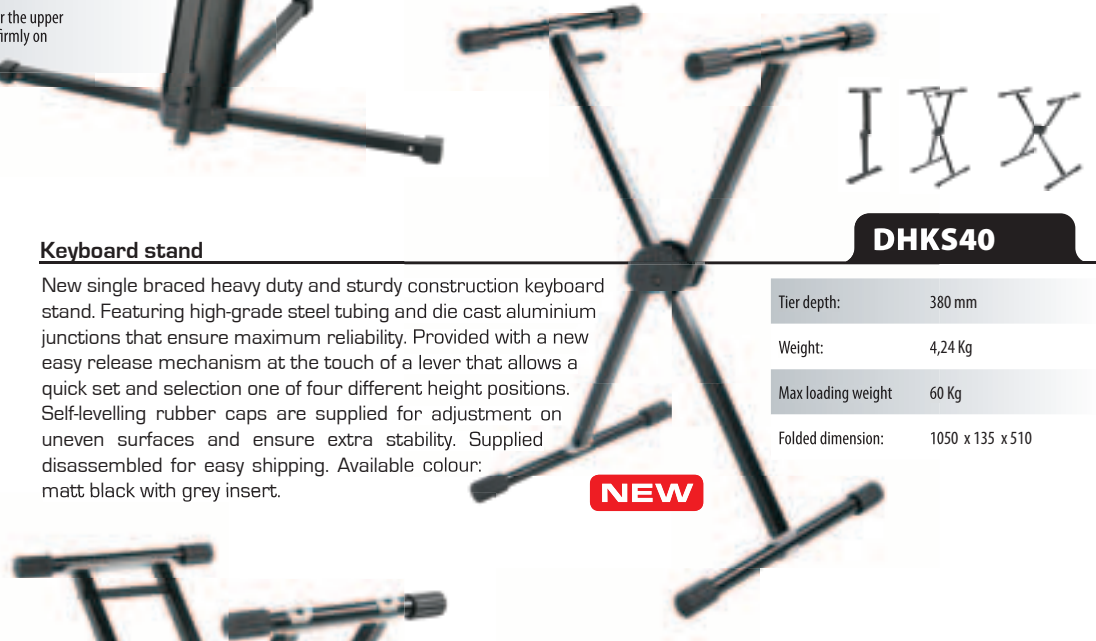

DHKS50

Tier depth	380 mm
Weight	7,34 Kg
Max loading weight	90 Kg
Folded dimension	1050 x 135 x 510

Keyboard stand

New double braced heavy duty and sturdy construction keyboard stand particularly suitable for larger keyboards and digital pianos. Featuring high-grade steel tubing and die cast aluminium junctions that ensure maximum reliability. Provided with a new easy release mechanism at the touch of a lever that allows a quick set and selection one of four different height positions. Self-levelling rubber caps are supplied for adjustment on uneven surfaces and ensure extra stability. Supplied disassembled for easy shipping. Available colour: matt black with grey insert.

NEW





MUSIC SHEET STANDS



NEW

DHMS80BK

Adjustable height:	1020 – 1560 mm
Weight	6,175 Kg
Ø Base	350 mm
Music sheet dimensions:	W 510 x H 330 mm

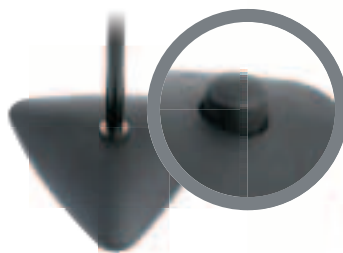

Music stand

Professional sheet music stand with easy release button in the floor base for quick and easy height adjustment.
Heavy triangular cast iron base for maximum stability. Available colour: matt black with grey insert.

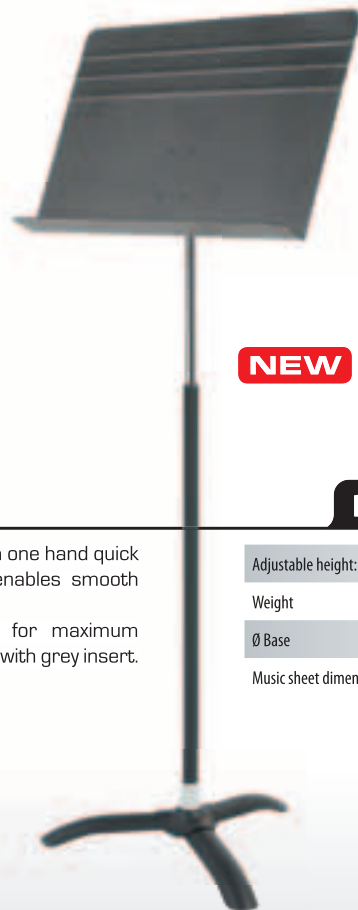

NEW

DHMS75BK

Adjustable height:	1060 – 1600 mm
Weight	2,720 Kg
Ø Base	500 mm
Music sheet dimensions:	W 510 x H 330 mm

Music stand

Professional sheet music stand with one hand quick release adjustment system that enables smooth and easy height adjustment.
Heavy triangular cast iron base for maximum stability. Available colour: matt black with grey insert.



Metal system

MICROPHONE STANDS

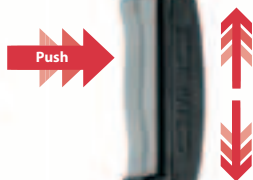
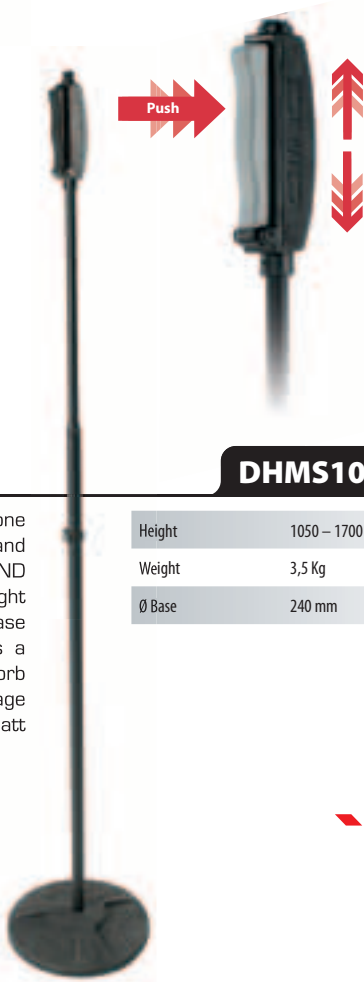

Microphone stand

DHMS10

- Professional straight microphone stand with cast-iron base and new ergonomic ONE-HAND system that allows simply height regulation. The cast-iron base ensures stability and features a rubber shock ring to help absorb unwanted noise from stage shaking. Available colour: matt black.

Height	1050 – 1700 mm
Weight	3,5 Kg
Ø Base	240 mm



NEW IMPROVED MECHANISM!

DHMS50

Microphone stands

Height	970 – 1500 mm
Weight	3,00 Kg
Ø Base	720 mm
Telescopic boom	590 – 950 mm

- Professional microphone stand with telescopic boom, lightweight aluminium base and high strength folding steel legs. The mic boom features our new and improved "push system" that allows full boom swivel adjustment with one button. Available colour: matt black.



DHMS60

NEW IMPROVED MECHANISM!

Microphone stand

Height	580 – 770 mm
Weight	2,60 Kg
Ø Base	720 mm
Telescopic boom	590 – 950 mm

- Professional microphone stand with telescopic boom, lightweight aluminium base and high strength folding steel legs. The mic boom features our new and improved "push system" that allows full boom swivel adjustment with one button. Available colour: matt black.



MICROPHONE STANDS

NEW

DHMS15BK

Microphone stand

Height	900 – 1600 mm
Weight	4,45 Kg
Ø Base	350 mm

- Professional straight microphone stand with one hand quick release adjustment system that enables smooth and easy height adjustment. Heavy triangular cast iron base for maximum stability. Available colour: matt black.

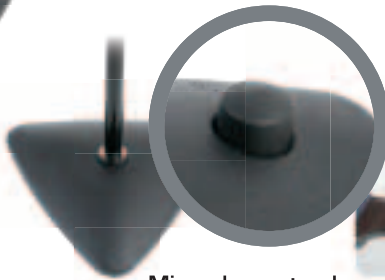
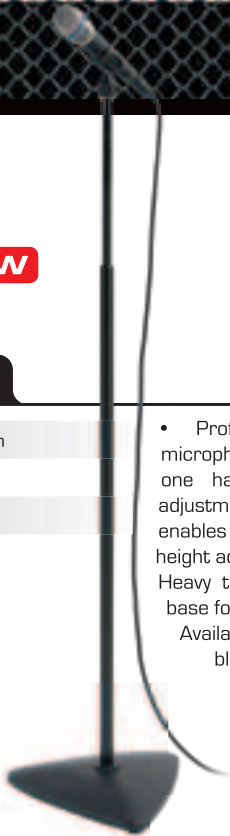

Microphone stand

Professional straight microphone stand with easy release button in the floor base for quick and easy height adjustment. Heavy triangular cast iron base for maximum stability. Available colours: matt black (DHMS70BK) or chrome (DHMS70CR).



DHMS70CH

DHMS70BK

Height	950 – 1600 mm
Weight	5,45 Kg
Ø Base	350 mm

NEW

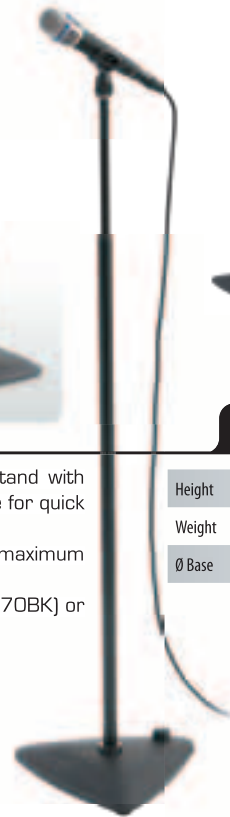

NEW

DHMS20

Microphone stand

Height	950 – 1650 mm
Weight	3,90 Kg
Ø Base	240 mm

- Professional straight microphone stand with cast-iron base and new Soft-Grip rubber covered sleeve to ensure a fast hold. The cast-iron base ensures stability and features a rubber shock ring to help absorb unwanted noise from stage shaking. Available colour: matt black.

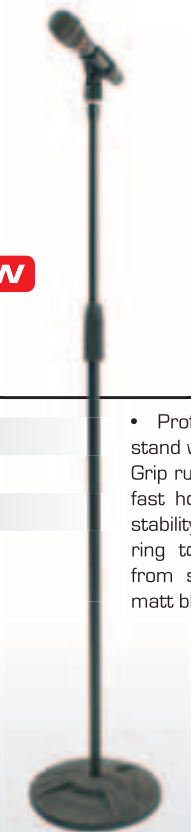



Metal system

SPEAKER/LIGHTING STANDS

DHSS10

HEIGHT ADJUSTABLE SATELLITE - SUBWOOFER SPACER

Height	1060 – 1710 mm
Weight	3,10 Kg
Ø Termination tube	35 mm

Satellite - subwoofer spacer

• New line of professional speaker / lighting stands constructed from robust steel tubes and die-cast aluminium. The lifting mechanism features a mechanical brake to guarantee maximum load stability and ease of set up. Available color: matt black (upper zinc tube).



DHSS20

HEIGHT ADJUSTABLE SPEAKER / LIGHTING STAND

Height	1400 – 2200 mm
Weight	8,50 Kg
Max load capacity	60 Kg
Ø Base	1300 mm
Ø Upper tube	35 mm

Speaker stand

• New line of professional speaker / lighting stands constructed from robust steel tubes and die-cast aluminium. The lifting mechanism features a mechanical brake to guarantee maximum load stability and ease of set up. Available color: matt black (upper zinc tube).

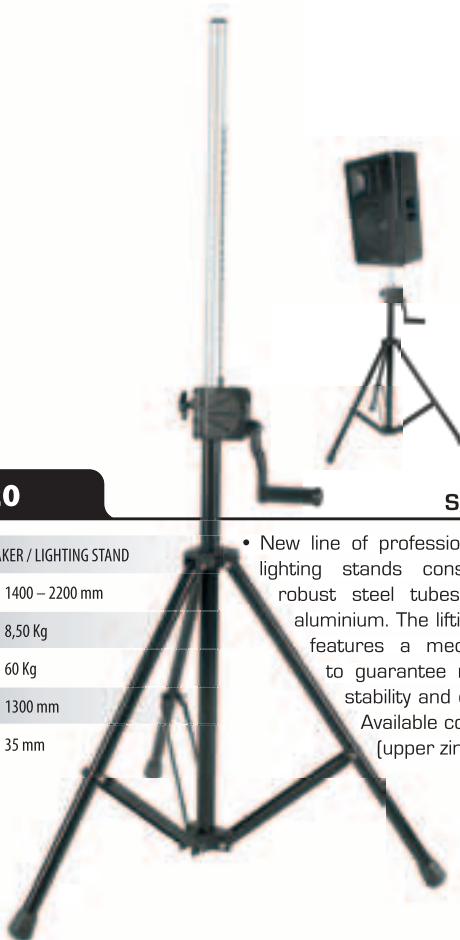

DHSS30

HEIGHT ADJUSTABLE SPEAKER / LIGHTING STAND

Height	1850 – 3200 mm
Weight	9,50 Kg
Max load capacity	50 Kg
Ø Base	1300 mm
Ø Upper tube	35 mm

Speaker/lighting stand

• New line of professional speaker / lighting stands constructed from robust steel tubes and die-cast aluminium. The lifting mechanism features a mechanical brake to guarantee maximum load stability and ease of set up. Available color: matt black (upper zinc tube).

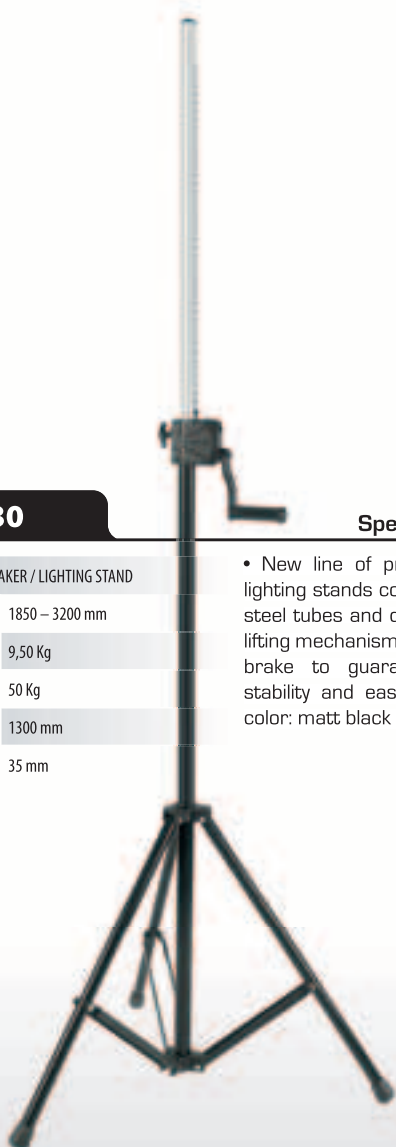



Cables

The DH series of cables from PROEL have evolved to the next level. Our R&D department are constantly looking at how the quality of a cable can affect a live performance and how they can improve the neutral, transparent, fluid and dynamic sound. Overcoming any possible distortion and with emphasis on continuing the improvement of all technical characteristics, durability, and reliability. As you have come to expect, DH cables are made from OFHC (Oxygen Free High Conductivity) Copper and due to its production in an Oxygen free environment, this is the nearest to 100% pure Copper available. As well as this, the DH series cables have an improved dense braided copper wire shield, covered by a flexible yet durable polyethylene insulation with an outside diameter of 6.5mm for the mic cables and 7mm for the instrument cables. The results from our continuing research into this series of products are the new "T"-Series and "X-Series" cables.



"X-SERIES" CABLES

Assembled with original Neutrik connectors with back housings and gold pins, the "X" series from DH is truly the professional's choice. The X series breaks all the boundaries you have come to expect from DH and exceeds them with its cutting-edge performance, high durability and use of quality industry standard connectors.



NEUTRIK

DHX150

CODE	Length
DHX150LU3	3 m
DHX150LU5	5 m
DHX150LU6	6 m
DHX150LU10	10 m

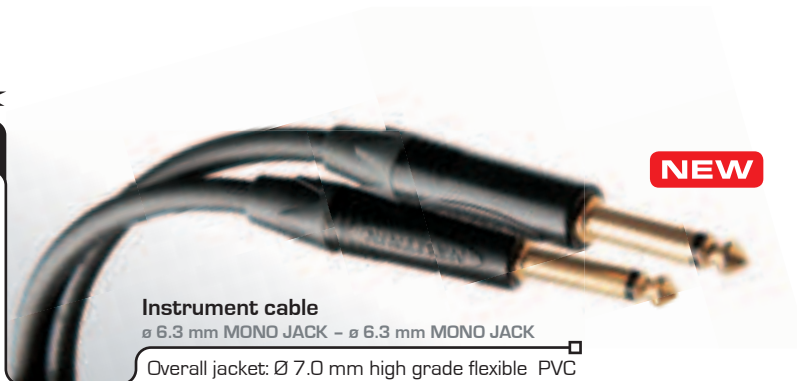

NEW

Instrument cable

ø 6.3 mm MONO JACK - ø 6.3 mm MONO JACK

Overall jacket: Ø 7.0 mm high grade flexible PVC
 1st shield: DH high conductivity PVC
 2nd shield: DH dense braided copper wire



NEUTRIK

DHX155

CODE	Length
DHX155LU5	5 m

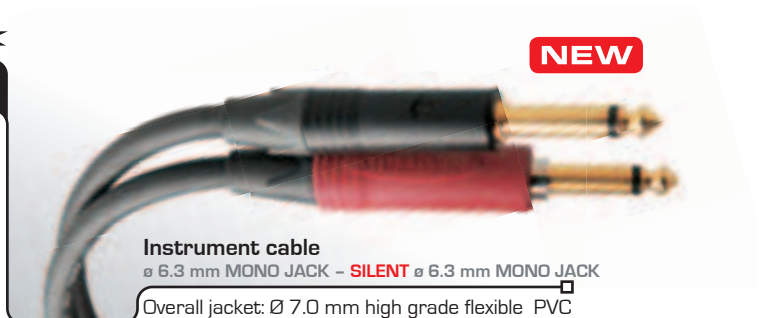

NEW

Instrument cable

ø 6.3 mm MONO JACK - **SILENT** ø 6.3 mm MONO JACK

Overall jacket: Ø 7.0 mm high grade flexible PVC
 1st shield: DH high conductivity PVC
 2nd shield: DH dense braided copper wire



NEUTRIK

DHX160

CODE	Length
DHX160LU3	3 m
DHX160LU5	5 m
DHX160LU6	6 m



NEW

Instrument cable

ø 6.3 mm MONO JACK
 RIGHT ANGLE ø 6.3 mm MONO JACK

Overall jacket: Ø 7.0 mm high grade flexible PVC
 1st shield: DH high conductivity PVC
 2nd shield: DH dense braided copper wire



NEUTRIK

DHX165

CODE	Length
DHX165LU5	5 m



Instrument cable

ø 6.3 mm MONO JACK - **SILENT** RIGHT ANGLE ø 6.3 mm MONO JACK

Overall jacket: Ø 7.0 mm high grade flexible PVC
 1st shield: DH high conductivity PVC
 2nd shield: DH dense braided copper wire



NEUTRIK

DHX260

CODE	Length
DHX260LU1	1 m
DHX260LU3	3 m
DHX260LU5	5 m
DHX260LU6	6 m
DHX260LU10	10 m



Microphone cable

XLR 3P MALE - XLR 3P FEMALE

Overall jacket: Ø 6.5 mm high grade flexible PVC
 1st shield: DH PVC
 2nd shield: DH dense braided copper wire



NEUTRIK

DHX360

CODE	Length
DHX360LU2	2 m
DHX360LU10	10 m
DHX360LU15	15 m
DHX360LU20	20 m



Speaker cable

2P SPEAKON - 2P SPEAKON

Overall jacket: Ø 8.8 mm high grade flexible PVC
 Conductors: 2 x 2.5 mm² / 13 AWG - OFHC

"T-SERIES" CABLES

Assembled with Rean connectors (a brand owned by Neutrik AG, the worldwide leader in professional audio connectors), the "T" series from DH have an excellent cost-performance ratio, attractive design and reliable functionality. The "T" series have an overmoulded backshell to ensure the most secure cable - connector fixing and help guarantee best performance.

CONNECTORS BY **REAN**
REAN a brand of Neutrik AG

DHT100

CODE	Length
DHT100LU05	0,5 m
DHT100LU1	1 m
DHT100LU2	2 m
DHT100LU3	3 m
DHT100LU5	5 m
DHT100LU6	6 m
DHT100LU10	10 m

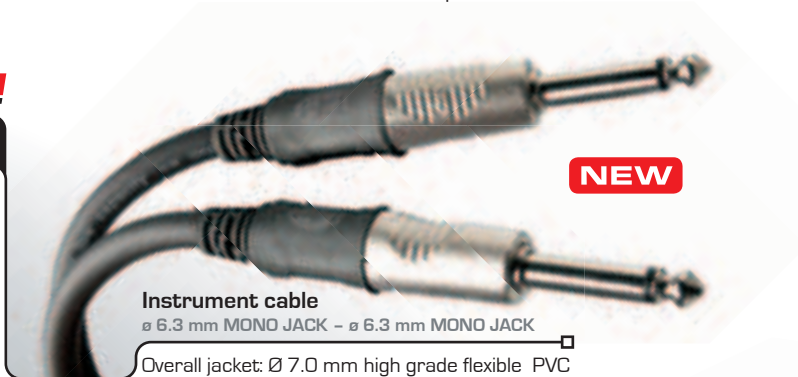

Instrument cable

ø 6.3 mm MONO JACK - ø 6.3 mm MONO JACK

Overall jacket: Ø 7.0 mm high grade flexible PVC

1st shield: DH high conductivity PVC

2nd shield: DH dense spiral copper wire

CONNECTORS BY **REAN**
REAN a brand of Neutrik AG

DHT120

CODE	Length
DHT120LU3	3 m
DHT120LU5	5 m
DHT120LU6	6 m



Instrument cable

ø 6.3 mm MONO JACK - ø 6.3 mm MONO JACK

Overall jacket: Ø 7.0 mm high grade flexible PVC

1st shield: DH high conductivity PVC

2nd shield: DH dense spiral copper wire

CONNECTORS BY **REAN**
REAN a brand of Neutrik AG

DHT140

CODE	Length
DHT140LU2	2 m
DHT140LU3	3 m
DHT140LU5	5 m

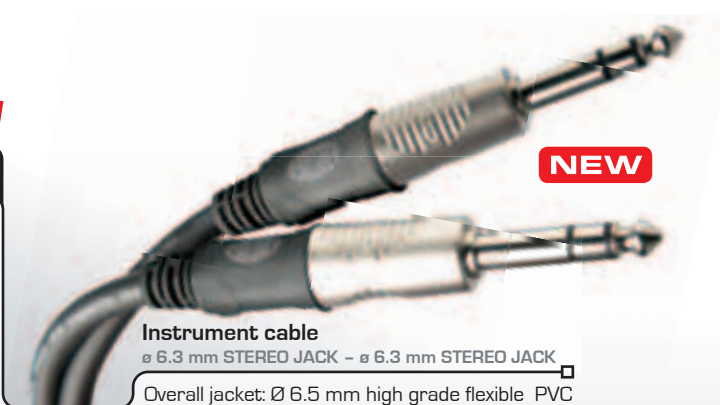

Instrument cable

ø 6.3 mm STEREO JACK - ø 6.3 mm STEREO JACK

Overall jacket: Ø 6.5 mm high grade flexible PVC

1st shield: DH PVC

2nd shield: DH dense spiral copper wire



CONNECTORS BY **REAN**
REAN a brand of Neutrik AG

DHT210

CODE	Length
DHT210LU1	1 m
DHT210LU3	3 m
DHT210LU5	5 m



NEW

Balanced cable
Ø 6.3 MM STEREO JACK - 3P FEMALE XLR
Overall jacket: Ø 6.5 mm high grade flexible PVC
1st shield: DH PVC
2nd shield: DH dense spiral copper wire

CONNECTORS BY **REAN**
REAN a brand of Neutrik AG

DHT230

CODE	Length
DHT230LU1	1 m
DHT230LU3	3 m
DHT230LU5	5 m



NEW

Balanced cable
Ø 6.3 MM STEREO JACK - 3P MALE XLR
Overall jacket: Ø 6.5 mm high grade flexible PVC
1st shield: DH PVC
2nd shield: DH dense spiral copper wire

CONNECTORS BY **REAN**
REAN a brand of Neutrik AG

DHT240

CODE	Length
DHT240LU1	1 m
DHT240LU2	2 m
DHT240LU3	3 m
DHT240LU5	5 m
DHT240LU10	10 m



NEW

Microphone cable
3P MALE XLR - 3P FEMALE XLR
Overall jacket: Ø 6.5 mm high grade flexible PVC
1st shield: DH PVC
2nd shield: DH dense spiral copper wire

"T-SERIES" CABLES

AUDIO INTERCONNECTIONS

This line includes, insert, "Y", adapters, as well as instrument cables. These DH cables are constructed with the purest OFHC copper will 100% overall shielding. These elements are encased in tough but flexible PVC jacket material.

CONNECTORS BY **IR**
REAN a brand of Neutrik AG **REAN**

DHT505

CODE	Length
DHT505	1,8 m



NEW

Adapter cable
2 x RCA M – 2 x RCA M

Overall jacket: 2 x Ø 6.0 mm high grade flexible PVC
1st shield: DH high conductivity PVC
2nd shield: DH dense spiral copper wire

CONNECTORS BY **IR**
REAN a brand of Neutrik AG **REAN**

DHT520

CODE	Length
DHT520	1,8 m
DHT520LU3	3 m

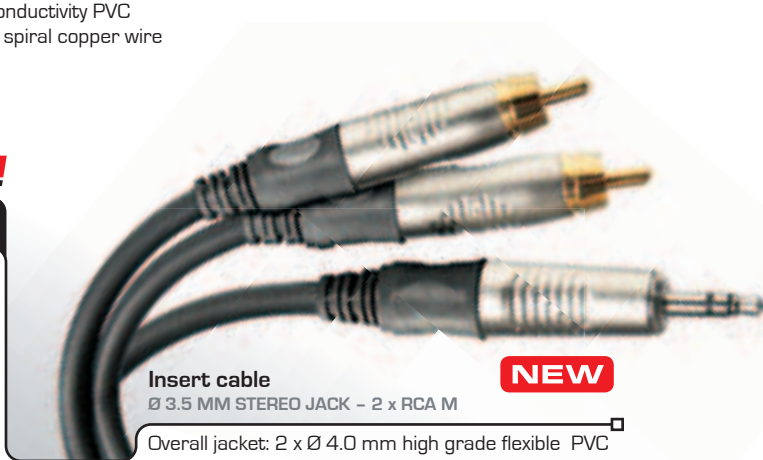

NEW

Insert cable
Ø 3.5 MM STEREO JACK – 2 x RCA M

Overall jacket: 2 x Ø 4.0 mm high grade flexible PVC
1st shield: DH high conductivity PVC
2nd shield: DH dense spiral copper wire

CONNECTORS BY **IR**
REAN a brand of Neutrik AG **REAN**

DHT530

CODE	Length
DHT530	1,8 m



NEW

Insert cable
Ø 3.5 MM STEREO JACK – 2 x RCA M

Overall jacket: 2 x Ø 6.0 mm high grade flexible PVC
1st shield: DH high conductivity PVC
2nd shield: DH dense spiral copper wire



CONNECTORS BY **REAN**
REAN a brand of Neutrik AG

DHT535

CODE	Length
DHT535	1,8 m
DHT535LU3	3 m
DHT535LU5	5 m



NEW

Adapter cable

2 x JACK MONO Ø 6.3 MM – 2 x RCA M
Overall jacket: 2 x Ø 6.0 mm high grade flexible PVC
1st shield: DH high conductivity PVC
2nd shield: DH dense spiral copper wire

CONNECTORS BY **REAN**
REAN a brand of Neutrik AG

DHT540

CODE	Length
DHT540	1,8 m
DHT540LU3	3 m
DHT540LU5	5 m



NEW

Insert cable

Ø 6.3 MM STEREO JACK – 2 x Ø 6.3 MM MONO JACK
Overall jacket: 2 x Ø 6.0 mm high grade flexible PVC
1st shield: DH high conductivity PVC
2nd shield: DH dense spiral copper wire

CONNECTORS BY **REAN**
REAN a brand of Neutrik AG

DHT545

CODE	Length
DHT545	1,8 m
DHT545LU3	3 m
DHT545LU5	5 m



NEW

Adapter cable

Ø 3.5 MM STEREO JACK – 2 x Ø 6.3 MM MONO JACK
Overall jacket: 2 x Ø 4.0 mm high grade flexible PVC
1st shield: DH high conductivity PVC
2nd shield: DH dense spiral copper wire

"T-SERIES" CABLES

CONNECTORS BY **IR REAN**
REAN a brand of Neutrik AG

DHT550

CODE	Length
DHT550	1,8 m
DHT550LU3	3 m

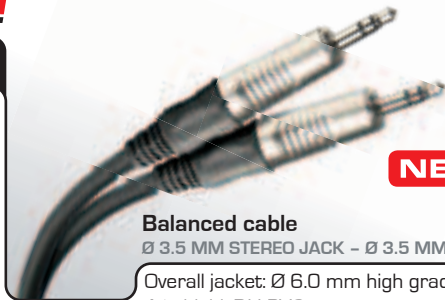

NEW

Balanced cable

Ø 3.5 MM STEREO JACK - Ø 3.5 MM STEREO JACK

Overall jacket: Ø 6.0 mm high grade flexible PVC

1st shield: DH PVC

2nd shield: DH dense spiral copper wire

CONNECTORS BY **IR REAN**
REAN a brand of Neutrik AG

DHT590

CODE	Length
DHT590	1,8 m



NEW

Adapter cable

Ø 3.5 MM STEREO JACK - 2 x 3P FEMALE XLR

Overall jacket: Ø 6.0 mm high grade flexible PVC

1st shield: DH PVC

2nd shield: DH dense spiral copper wire

CONNECTORS BY **IR REAN**
REAN a brand of Neutrik AG

DHT595

CODE	Length
DHT595	1,8 m

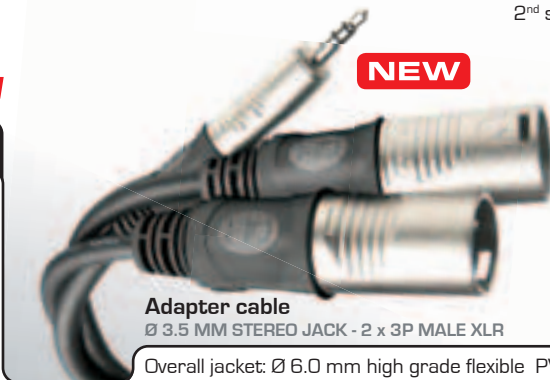

NEW

Adapter cable

Ø 3.5 MM STEREO JACK - 2 x 3P MALE XLR

Overall jacket: Ø 6.0 mm high grade flexible PVC

1st shield: DH PVC

2nd shield: DH dense spiral copper wire

CONNECTORS BY **IR REAN**
REAN a brand of Neutrik AG

DHT600

CODE	Length
DHT600LU015	0,15 m
DHT600LU030	0,30 m



NEW

Instrument cable

Ø 6.3 MM RIGHT ANGLE MONO JACK

Ø 6.3 MM RIGHT ANGLE MONO JACK

Overall jacket: Ø 7.0 mm high grade flexible PVC

1st shield: DH high conductivity PVC

2nd shield: DH dense spiral copper wire



ADAPTERS

Complete line of Professional adapters for different interconnecting solutions. They are constructed with solid metal body with external Black ABS covering and 24k Gold plated corrosion free connections.

DHMA290

Ø 6.3 MM MONO JACK
3P FEMALE XLR



DHMA295

Ø 6.3 MM STEREO JACK
3P FEMALE XLR



DHMA300

Ø 6.3 MM MONO JACK
3P MALE XLR



DHMA305

Ø 6.3 MM STEREO JACK
3P MALE XLR



DHMA320

Ø 6.3 MM MONO JACK SOCKET
3P MALE XLR



Adapters

DHMA500

RCA FEMALE
3P MALE XLR



3P XLR MALE
Ø 6.3 MM STEREO JACK SOCKET

DHMA615



DHMA625

3P FEMALE XLR
Ø 6.3 MM STEREO JACK SOCKET



Ø 3.5 MM STEREO JACK
Ø 6.3 MM STEREO JACK SOCKET

DHPA120



DHPA158

Ø 6.3 MM MONO JACK
Ø 3.5 MM STEREO JACK SOCKET





□ Ø 6.3 MM STEREO JACK
□ Ø 3.5 MM STEREO JACK SOCKET

DHPA165



□ Ø 6.3 MM STEREO JACK
□ 2 X Ø 3.5 MM STEREO JACK SOCKET

DHPA170



□ Ø 3.5 MM STEREO JACK
□ 2 X Ø 3.5 MM STEREO JACK SOCKET

DHPA140



□ Ø 3.5 MM STEREO JACK SOCKET
□ Ø 3.5 MM STEREO JACK SOCKET

DHPA108



□ RCA SOCKET
□ RCA SOCKET

DHPA210

Adapters



DHPA180

□ RCA MALE
□ Ø 6.3 MM MONO JACK SOCKET



DHPA190

□ Ø 6.3 MM MONO JACK
□ RCA FEMALE



DHPA250

□ Ø 6.3 MM STEREO JACK
□ 2 X RCA FEMALE



DHPA122A

□ Ø 3.5 MM STEREO JACK
□ Ø 3.5 MM STEREO JACK SOCKET



AUDIO STAGE BOXES

In the tradition of DH design philosophy, DH Audio Stage Boxes are the product of constant research into new ideas and applications. This philosophy constantly drives our engineers to find better materials, faster processes, and more efficient solutions to everyday sound problems.

The latest advances for DH Stage Boxes feature- New multi-pair cable that employs OFHC copper for the purest signal transfer- Patented gold plated DH XLR's. Protective fan sleeve material that is flexible and durable - a new system of tough nylon panel and circuit board mount connectors for long lasting performance and ease of assembly- New "combo" sockets that accept an input from an XLR or 1/4" TRS connector.

The aluminum housing or "stage box," is lightweight and features a hard finish with scuff resistant channel markings. Each box has 4ea. "combo" inputs in addition to the sends.





Audio Stage Boxes

DHBOX12IN

• Audio Stage box equipped with 8 x 3 pole panel mount XLR female and 4 x COMBO 3 pole XLR female / Ø6.3 mm STEREO JACK socket. Professional multi-pair Audio cable with 12 x 3 pole panel mount XLR male

20 M CABLE LENGTH



DHBOX1204

• Audio Stage box equipped with 8 x 3 pole panel mount XLR female, 4 x COMBO 3 pole XLR female / Ø6.3 mm STEREO JACK socket and 4 x 3 pole panel mount XLR male. Professional multi-pair Audio cable with 12 x 3 pole cable mount XLR male and 4 x 3 pole XLR female.

30 M CABLE LENGTH





DHBOX1604

• Audio Stage box equipped with 12 x 3 pole panel mount XLR female, 4 x COMBO 3 pole XLR female / Ø 6.3 mm STEREO JACK socket and 4 x 3 pole panel mount XLR male. Professional multi. PAIR Audio cable with 16 x 3 pole cable mount XLR male and 4 x 3 pole XLR female.



30 M CABLE LENGTH

DHBOX2408

• Audio Stage box equipped with 20 x 3 pole panel mount XLR female, 4 x COMBO 3 pole XLR female / Ø 6.3 mm STEREO JACK socket and 4 x 3 pole panel mount XLR male. Professional multi-pair. Audio cable with 24 x 3 pole cable mount XLR male and 8 x 3 pole XLR female.



30 M CABLE LENGTH



Accessories



DHATK
Anti.theft mechanism



DHCLM
Magnetic key ring



ANTI-THEFT MECHANISM

The anti-theft mechanism developed for DH permits the products to be secured to the display using a simple, but effective magnetic lock. Obviously, in order to avoid that anyone can open the lock, it is designed to be opened only with the coupled key. Even the hook on which this lock is positioned was purpose-designed by PROEL.

Hooks, locks and keys can be ordered separately, allowing the customization of the DH display to suit the dealers needs.



DHHOOK

METAL HOOK

Width	42 mm
Height	28 mm
Depth	200 mm



DHDISPLAY

This free-standing elliptical display has been thought to maximize the floor space of the store. Can be used as a double side display or with a L shape to which you can add a second one to form a cube or fully extended. The map for displaying the product will make easy for anyone to set it up.

DHDISPLAY

DOUBLE SIDE CABLE DISPLAY

Width	920 mm
Height	2045 mm
Depth	600 mm (base) • 295 mm (BODY)



DHDISPLAYW

WALL MOUNT CABLE / ACCESSORIES DISPLAY

Width	735 mm
Height	1105 mm • 1245 mm
Depth	55 mm • 130 mm



BAGS

The new DH Bags line is the result of a careful and targeted market analysis aimed to define the understanding of specific needs demonstrated by students and professional musicians who regularly use cases to carry their musical instruments around with them. This analysis has delivered an exciting result that led to the creation of two separate product lines. With the objective of improving the offer to this market and to respond to the dedicated needs of these users.

Hence the SUN series, guitar bags and Moon series, a more complex line of professional fabric bags, all manufactured using the highest quality standards available.



SUN SERIES



The Sun series was studied for students and musicians that are looking for quality and practicality, at a highly competitive price point. All bags are made from high quality 420D Rugged polyester material with reinforced seams and DHFOAM padding.

The Standard Sun series bags incorporate the following features:

- 20mm DHFOAM® padding – composed of 10mm High Density Foam, equivalent of 25mm standard foam and 10mm standard foam.
- Adjustable padded rucksack straps.
- Ergonomic mesh lumbar support Comfortable foam mesh handle Reflective safety strips. Soft Nylon 190D non-scratch interior lining with sewn-in additional protection for bridge and mechanics. Large front pocket for music books provided with padded laptop protection pouch.
- Additional round shaped front accessory pocket with Velcro tie for cable and internal organiser pouches Metal moulded DH zip pulls.

Features of the new DHSUN100 Series:

- 8mm DHFOAM® padding .
- Adjustable rucksack straps.
- Comfortable foam mesh handle. Soft Nylon 190D non-scratch interior lining with sewn-in additional protection for bridge and mechanics. Large front pocket for music books.
- Metal moulded DH zip pulls.





GUITAR & BASS BAGS



DHSCG100

Classic guitar bag made of water-proof nylon 420D with 8 mm DH foam padding. Provided with a large front pocket and two practical adjustable shoulder straps. Available colour: black.

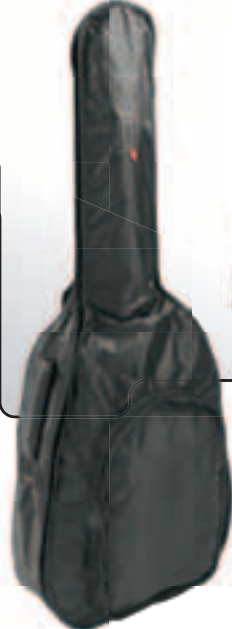

NEW

CLASSIC GUITAR BAG

DHSAG100

Acoustic / Folk guitar bag made of water-proof nylon 420D with 8mm DH foam padding. Provided with a large front pocket and two practical adjustable shoulder straps. Available colour: black.



NEW

ACOUSTIC/FOLK GUITAR BAG



DHSEG100

Electric guitar bag made of water-proof nylon 420D with 8mm DH foam padding. Provided with a large front pocket and two practical adjustable shoulder straps. Available colour: black.

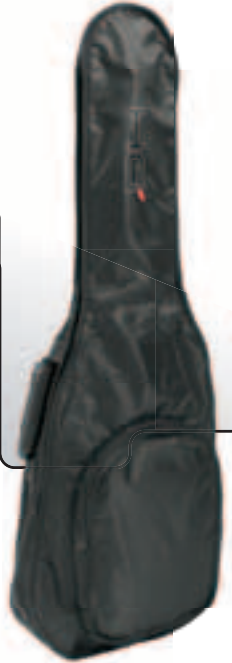

NEW

ELECTRIC GUITAR BAG

DHSBG100

Electric bass bag made of water-proof nylon 420D with 8mm DH foam padding. Provided with a large front pocket and two practical adjustable shoulder straps. Available colour: black.



NEW

ELECTRIC BASS BAG



Bags

GUITAR & BASS BAGS



DHSAG

Acoustic / Folk guitar bag made of water-proof 420D polyester material. Provided with 20mm DHFOAM® padding, adjustable padded rucksack straps, ergonomic mesh lumbar support and comfort mesh handles. Featuring also a soft non scratch interior lining, large front pockets and metal moulded DH zip pulls. Available colour: black.



ACOUSTIC/FOLK GUITAR BAG

DHSEG

Electric guitar bag made of water-proof 420D polyester material. Provided with 20mm DHFOAM® padding, adjustable padded rucksack straps, ergonomic mesh lumbar support and comfort mesh handles. Featuring also a soft non scratch interior lining, large front pockets and metal moulded DH zip pulls. Available colour: black.



ELECTRIC GUITAR BAG

DHSCG

Classic guitar bag made of water-proof 420D polyester material. Provided with 20mm DHFOAM® padding, adjustable padded rucksack straps, ergonomic mesh lumbar support and comfort mesh handles. Featuring also a soft non scratch interior lining, large front pockets and metal moulded DH zip pulls. Available colour: black.



CLASSIC GUITAR BAG

DHSBG

Electric bass bag made of water-proof 420D polyester material. Provided with 20mm DHFOAM® padding, adjustable padded rucksack straps, ergonomic mesh lumbar support and comfort mesh handles. Featuring also a soft non scratch interior lining, large front pockets and metal moulded DH zip pulls. Available colour: black.



ELECTRIC BASS BAG



MOON SERIES



This series, was studied to offer the maximum protection and to satisfy all the musicians requirements and are the result of a long study of the worldwide market.

All bags are made from high quality 600D Rugged waterproof polyester material with reinforced seams and DHFOAM padding . This series also features:

- 600D Rugged waterproof polyester material durable construction.
- 30mm DHFOAM® padding - composed of 10mm High Density Foam, equivalent of 25mm standard foam and 20mm standard foam.
- Adjustable padded rucksack straps with MP3 and cell phone pockets.
- Ergonomic mesh lumbar support.
- Comfortable foam mesh handle.
- Reflective safety strips (guitar bags only).
- Soft non-scratch interior lining with sewn-in additional protection for bridge and mechanics.
- Heavy duty EVA moulded detachable backpack with zipper and buckles provided with padded laptop protection pouch and additional organiser pouches (guitar bags only)
- Metal moulded DH zip pulls.

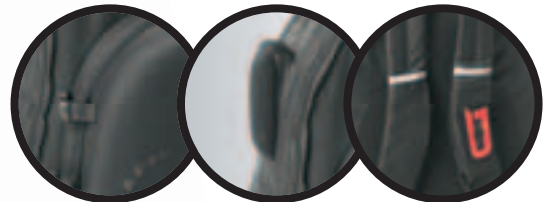



DHMAG

Professional Acoustic / Folk guitar bag made of water-proof and rugged 600D polyester material. Provided with 30mm DHFOAM® padding, adjustable padded rucksack straps with additional MP3 and cell phone pockets, ergonomic mesh lumbar support and comfort mesh handles.

Featuring also soft non scratch interior lining, heavy duty EVA moulded detachable backpack with padded laptop protection pouch and additional organiser pouches and metal moulded DH zip pulls. Available colour: black.



ACOUSTIC GUITAR BAG



DHMDEG

Professional Electric guitar bag made of water-proof and rugged 600D polyester material. Provided with 30mm DHFOAM® padding, adjustable padded rucksack straps with additional MP3 and cell phone pockets, ergonomic mesh lumbar support and comfort mesh handles.

Featuring also soft non scratch interior lining, heavy duty EVA moulded detachable backpack with padded laptop protection pouch and additional organiser pouches and metal moulded DH zip pulls. Available colour: black.



DOUBLE ELECTRIC GUITAR BAG



DHMCG

Professional Classic guitar bag made of water-proof and rugged 600D polyester material. Provided with 30mm DHFOAM® padding, adjustable padded rucksack straps with additional MP3 and cell phone pockets, ergonomic mesh lumbar support and comfort mesh handles.

Featuring also soft non scratch interior lining, heavy duty EVA moulded detachable backpack with padded laptop protection pouch and additional organiser pouches and metal moulded DH zip pulls. Available colour: black.



CLASSIC GUITAR BAG





DHMBG

Professional Electric bass bag made of water-proof and rugged 600D polyester material. Provided with 30mm DHFOAM® padding, adjustable padded rucksack straps with additional MP3 and cell phone pockets, ergonomic mesh lumbar support and comfort mesh handles. Featuring also soft non scratch interior lining, heavy duty EVA moulded detachable backpack with padded laptop protection pouch and metal moulded DH zip pulls. Available colour: black.



ELECTRIC BASS BAG

DHMDBG

Professional double Electric bass bag made of water-proof and rugged 600D polyester material. Provided with 30mm DHFOAM® padding, adjustable padded rucksack straps with additional MP3 and cell phone pockets, ergonomic mesh lumbar support and comfort mesh handles. Featuring also soft non scratch interior lining, heavy duty EVA moulded detachable backpack with padded laptop protection pouch and metal moulded DH zip pulls. Available colour: black.



DOUBLE ELECTRIC BASS BAG

DHMEG

Professional double Electric guitar bag made of water-proof and rugged 600D polyester material. Provided with 30mm DHFOAM® padding, adjustable padded rucksack straps with additional MP3 and cell phone pockets, ergonomic mesh lumbar support and comfort mesh handles. Featuring also soft non scratch interior lining, heavy duty EVA moulded detachable backpack with padded laptop protection pouch and additional organiser pouches and metal moulded DH zip pulls. Available colour: black.



ELECTRIC GUITAR BAG

WOOD INSTRUMENTS BAGS



DHMCL44

Professional 4/4 Cello bag made of water-proof and rugged 600D polyester material. Provided with 30mm

DHFOAM® padding, adjustable padded rucksack straps for an easy carrying. It features also ergonomic mesh lumbar support and comfort mesh handles; large front pockets for bow and accessories.

Soft non scratch interior lining, back side large pouch for music books and metal moulded DH zip pulls. Available colour: black.



4/4 CELLO BAG



WIND INSTRUMENTS BAGS



DHMTSX

Professional Tenor Sax reinforced bag made of water-proof and rugged 600D polyester material. Provided with 30mm DHFOAM® padding and 3mm extra soft foam covered with black soft velvet. Adjustable and detachable padded straps with metal hardware. Additional pockets for accessories and large pouch for music stand. Available colour: black.



TENOR SAX BAG

DHMASX

Professional Alto Sax reinforced bag made of water-proof and rugged 600D polyester material. Provided with 30mm DHFOAM® padding and 3mm extra soft foam covered with black soft velvet. Adjustable and detachable padded straps with metal hardware. Additional pockets for accessories and large pouch for music stand. Available colour: black.



ALTO SAX BAG

DHMTB

Professional Trombone reinforced bag made of water-proof and rugged 600D polyester material. Provided with 30mm DHFOAM® padding and 3mm extra soft foam covered with black soft velvet. Strong adjustable and detachable padded straps with metal hardware. Comfortable foam mesh carrying handles. Additional pockets with internal organiser pouches and special protection side padding. Available colour: black.



TROMBONE BAG

DHMTPT

Professional Trumpet reinforced bag made of water-proof and rugged 600D polyester material. Provided with 30mm DHFOAM® padding and 3mm extra soft foam covered with black soft velvet. Strong adjustable and detachable padded straps with metal hardware. Comfortable foam mesh carrying handles. Additional pockets with internal organiser pouches and special protection side padding. Available colour: black.



TRUMPET BAG

WIND INSTRUMENTS BAGS



DHMDTP

Professional Triple Trumpet bag made of water-proof and rugged 600D polyester material. Provided with 30mm DHFOAM® padding with 3mm extra soft foam covered with black soft velvet and inner dedicated compartments. Strong adjustable and detachable strap with metal hardware. Additional front pocket for accessories and metal moulded DH zip pulls. Available colour: black.



TRIPLE TRUMPET BAG



DHMCL

Clarinet case made of heavy duty EVA covered with water-proof and rugged 600d polyester material and inner soft black velvet lining. It also features adjustable padded rucksack straps with MP3 and cell phone pockets. Available colour: black.



CLARINET CASE



DHMFL

Traversen Flute case made of heavy duty EVA covered with water-proof and rugged 600d polyester material and inner soft black velvet lining. It also features adjustable padded rucksack straps with MP3 and cell phone pockets. Available colour: black.



TRAVERSEN FLUTE CASE



KEYBOARD BAGS



DHMKEY61

DHMKEY

Range of Professional keyboard bags made of 600D rugged and water-proof polyester material durable construction with 30mm DHFOAM® padding and 3mm extra inner soft lining. Featuring strong adjustable and detachable padded strap with metal hardware, comfortable foam mesh carrying handles and three A4 DIN size pockets for books and accessories. It's also equipped with inner padded straps to hold the instrument and two pairs of strong wheels for a practice and comfortable carriage. Available colour: black.



DHMKEY76

KEYBOARD BAG



DHMKEY88

Model	Description	Inner dimension
DHMKEY61	61 key keyboard bag	1090 x 445 x 165 mm
DHMKEY76	76 key keyboard bag	1300 x 450 x 170 mm
DHMKEY88	88 key keyboard bag	1460 x 457 x 160 mm

DRUM BAGS



DHMDR

Wide range of Professional bags for drum kits. Featuring 600D rugged and water-proof polyester material durable construction with 30mm DHFOAM padding and 3mm extra inner soft foam with black velvet lining. They are also equipped with a large pocket for spare head, padded strap with metal hardware and two comfortable foam mesh carrying handles. Strong zipper with metal moulded DH zip pulls. All carrying parts are specially reinforced. All the DH drum bags fit drums with rims mounting. Available colour: black.



DHKS10SL

DHKS10SL

DHKS10SL

DRUM KIT BAG

DHKS10SL

DHKS10SL

Model	Descriptions
DHMDRT10	10" TOM TOM
DHMDRT12	12" TOM TOM
DHMDRT13	13" TOM TOM
DHMDRT14	14" TOM TOM
DHMDRT16	16" TOM TOM
DHMDRFT14	14" FLOOR TOM
DHMDRFT16	16" FLOOR TOM
DHMDRFT18	18" FLOOR TOM
DHMDS13	13" SNARE (5")
DHMDS14	14" SNARE (6" 1/2)
DHMDRB18	18" BASS DRUM
DHMDRB20	20" BASS DRUM
DHMDRB22	22" BASS DRUM

HARDWARE BAGS

DHMCY

Professional Cymbals bag made from water resistant 600D nylon with padding DHFOAM 30 mm and inside dedicated compartments lined with soft black velvet. It has a large front pocket for accessories. It's also equipped with adjustable padded shoulder strap and adjustable padded back straps provided with additional pockets for cell phone/MP3/MP4 reader. Available colour: black.



CYMBALS BAG



DHMSTICK

Professional drum-sticks bag made of water resistant 600D nylon with 20mm DHFOAM padding 20 mm and multiple internal compartments dedicated for the drumsticks and accessories. With large external pockets. It's also equipped with adjustable padded shoulder strap for easy carrying. Available colour: black.



DRUM-STICKS BAG

DHMHDW1

Professional hardware bag made of 600D rugged and water-proof polyester material durable construction with 30mm DHFOAM@ padding. Featuring two front large pockets, strong adjustable and detachable padded strap with metal hardware and two strong wheels for a practice carriage. Strong zipper with metal moulded DH zip pulls. Available colour: black.



HARDWARE BAG



ALPHABETICAL INDEX

DHATK	28	DHMA625	22	DHMFL	38
DHBOX12IN	26	DHMAG	34	DHMHDW1	40
DHBOX1204	26	DHMASX	37	DHMKEY61	39
DHBOX1604	27	DHMBG	35	DHMKEY76	39
DHBOX2408	27	DHMCG	34	DHMKEY88	39
DHCLM	28	DHMCL	38	DHMS10	10
DHDISPLAY	28	DHMCL44	36	DHMS15	11
DHDISPLAYW	28	DHMCY	40	DHMS20	11
DHGS10	6	DHMDBG	35	DHMS50	10
DHGS40	6	DHMDEG	35	DHMS60	10
DHGSW15	7	DHMDRB18	39	DHMS70BK	11
DHGSW25	7	DHMDRB20	39	DHMS70CH	11
DHGSW35	7	DHMDRB22	39	DHMS75	9
DHHOOK	28	DHMDRFT14	39	DHMS80	9
DHKS10BK	8	DHMDRFT16	39	DHMSTICK	40
DHKS10SL	8	DHMDRFT18	39	DHMTB	37
DHKS40	8	DHMDRS13	39	DHMTP	37
DHKS50	8	DHMDRS14	39	DHMtsx	37
DHMA290	21	DHMDRT10	39	DHPA108	23
DHMA295	21	DHMDRT12	39	DHPA120	22
DHMA300	21	DHMDRT13	39	DHPA122A	24
DHMA305	21	DHMDRT14	39	DHPA140	23
DHMA320	21	DHMDRT16	39	DHPA158	22
DHMA500	22	DHMDTP	38	DHPA165	23
DHMA615	22	DHMEG	34	DHPA170	23



ALPHABETICAL INDEX

DHPA180	24	DHT140LU3	16	DHT550	20
DHPA190	24	DHT140LU5	16	DHT550LU3	20
DHPA210	23	DHT210LU1	17	DHT590	20
DHPA250	24	DHT210LU3	17	DHT595LU3	20
DHSAG	32	DHT210LU5	17	DHT600	20
DHSAG110	31	DHT230LU1	17	DHT600LU015	20
DHSBG	32	DHT230LU3	17	DHX150LU3	14
DHSBG130	31	DHT230LU5	17	DHX150LU5	14
DHSCG	32	DHT240LU1	17	DHX150LU6	14
DHSCG100	31	DHT240LU2	17	DHX150LU10	14
DHSEG	32	DHT240LU3	17	DHX155LU5	14
DHSEG120	31	DHT240LU5	17	DHX160LU3	14
DHSS10	12	DHT240LU10	17	DHX160LU5	14
DHSS20	12	DHT505	18	DHX160LU6	14
DHSS30	12	DHT520	18	DHX165LU5	15
DHT100LU1	16	DHT520LU3	18	DHX260LU1	15
DHT100LU2	16	DHT530	18	DHX260LU3	15
DHT100LU3	16	DHT535	19	DHX260LU5	15
DHT100LU5	16	DHT535LU3	19	DHX260LU6	15
DHT100LU05	16	DHT535LU5	19	DHX260LU10	15
DHT100LU6	16	DHT540	19	DHX360LU2	15
DHT100LU10	16	DHT540LU3	19	DHX360LU10	15
DHT120LU3	16	DHT540LU5	19	DHX360LU15	15
DHT120LU5	16	DHT545	19	DHX360LU20	15
DHT120LU6	16	DHT545LU3	19		
DHT140LU2	16	DHT545LU5	19		

CATALOGUE CODE

DHCAT11E

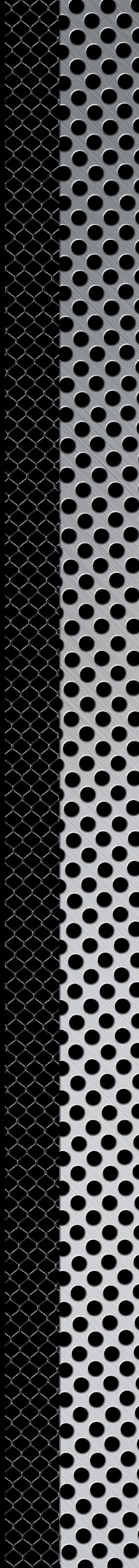



PROEL
America Ll.
Miami
USA

PROEL
International Ltd.
London
UK

PROEL
Korea Co. Ltd.
Gyunggi-Do
KOREA

TURBOSOUND L.T.D.
West Sussex
UK

PROEL SPA
(Worldwide Headquarters)
Via alla Ruenia, 37/43
64027 Sant'Omero (Te) - ITALY
Tel. +39 0861 81241
Fax +39 0861 887862
P.I. 00778590679
N.Reg.AEE IT 0802000002762

info@proelgroup.com
www.proel.com

www.facebook.com/proel
www.youtube.com/proelgroup

PROEL GROUP  BRAND

DH Catalogue

